

Zero Static Use Points

Zero Static Tee (ZSBT)

Zero Static use points are some of the most critical valves utilized in the Biopharmaceutical industry. Use point valves allow process fluids to be transferred, sampled, drained or diverted with minimal impact on critical systems such as WFI and purified water.

Zero static Tees are some of the most critical valves utilized in the Biopharmaceutical Industry. They substantially reduce dead leags and minimize the potential for contamination.

Typical Applications:

- Point-of-use valves
- Piping Branch valves



Flow Path

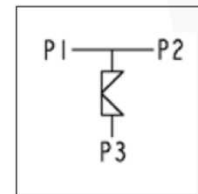

Integrated Block Valves

Zero Static U-Bend (ZSBBVV, ZSBBHV, EZSBVV, EZSBHV)

Zero Static use points are some of the most critical valves utilized in the Biopharmaceutical industry. Use point valves allow process fluids to be transferred, sampled, drained or diverted with minimal impact on critical systems such as WFI and purified water.

The E-Series zero static u-bend maintains the essential functional characteristics of the original zero static valve design while improving the cost effectiveness of block body assemblies. The design also utilizes ASME autoweld elbow fittings, resulting in an increased u-bend centerline dimension as compared to the original zero static valve design. All elbow welds are left in the as-welded condition. Outlet fitting welds are polished to valve surface finish requirements.

Typical Applications:

- Point-of-use valves
- Piping branch valves

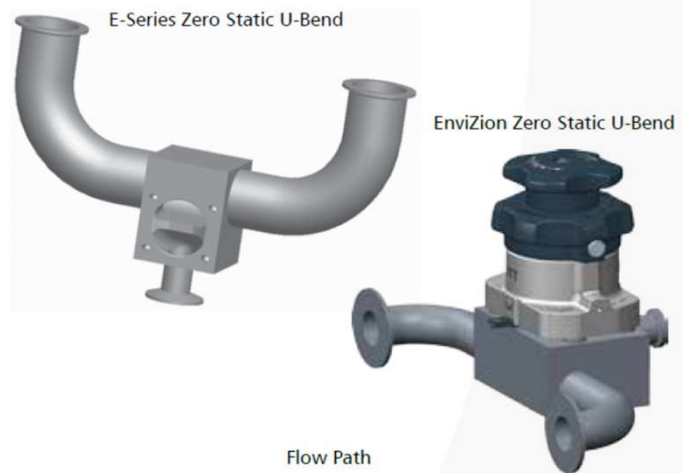

Flow Path

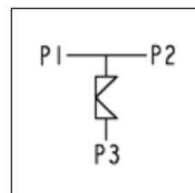

VALVULAS Y PROCESOS 2007, S.L.

Orfeo Català, nr. 9
Pol. Ind. Sud
08440 - CARDEDEU
SPAIN

TEL: 00 34 93 755 20 56
FAX: 00 34 93 755 17 75
e-mail: jpicallo@vypsl.es
VAT: ESB64719958

Zero Static Use Points

Zero Static Back to Back Sample (ZSBBS)

The ZSBBS process fabrication is a modification of a standard Zero Static Tee. An integral valve located on the back of the valve assembly provides access to a sample port upstream of the Zero Static Tee weir. This sample port is utilized to take samples of the main process flow. The sample valve typically utilizes a .5" Bio-Tek or Pure-Flo valve.

The integral sample valve greatly reduces contact surfaces, hold up volume and possible deadlegs as compared to sample valves that are welded to the exterior of a standard Zero Static valve. The ZSBBS is an essential element of piping systems required to meet demanding L/D ratios suggested by the ASME BPE standard.

Typical Applications:

- Use point where sampling of loop water is required prior to opening main valve.

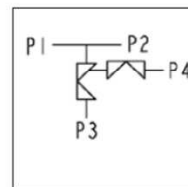

Flow Path



Zero Static Downstream Purge (ZDPT/ZDPB)

The ZDPT and ZDPB process fabrication is a modification of a standard Zero Static valve. An integral valve located on the back of the valve assembly provides access to a purge port downstream of the main weir. This purge can be utilized for a multitude of process and utility applications including steam, CIP solution or as a gas purge. The down stream integral purge valve typically utilizes a .5" Pure-Flo valve bonnet assembly. The integral purge valve greatly reduces contact surfaces, hold up volume and possible deadlegs as compared to purge valves that are welded to the exterior of a standard zero static valve. The ZDPT and ZDPB are an essential element of piping systems required to meet demanding L/D ratios suggested by the ASME BPE standard.

Typical Applications:

- Use point applications where cleaning (CIP), steam sterilization, and blow down of the downstream is required.

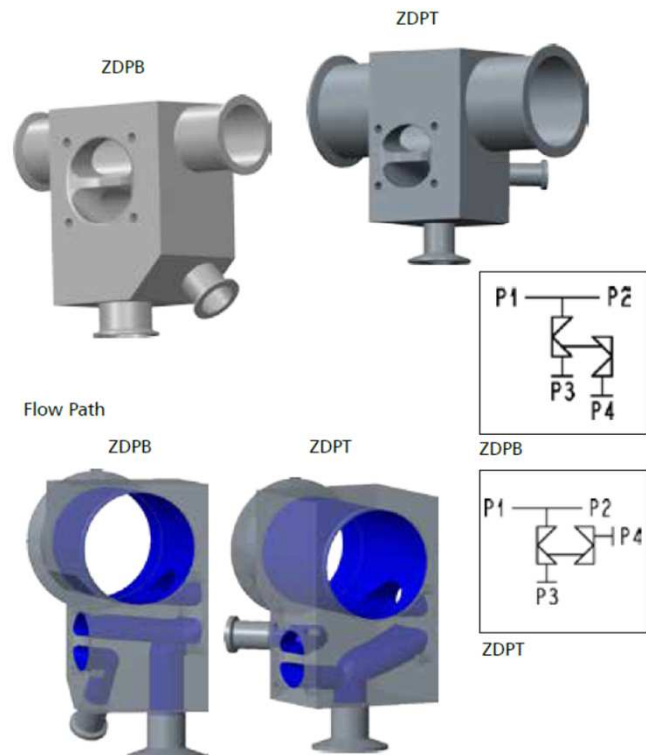

VALVULAS Y PROCESOS 2007, S.L.

Orfeó Català, nr. 9
Pol. Ind. Sud
08440 - CARDEDEU
SPAIN

TEL: 00 34 93 755 20 56
FAX: 00 34 93 755 17 75
e-mail: jpicallo@vypls.es
VAT: ESB64719958

Zero Static Use Points

Zero Static with Upstream Sample and Downstream Purge (ZUD)

The Zero Static Upstream Sample and Downstream Purge valve allows for point of use sampling of the upstream flow, purging and sterilization of the downstream process, and sampling from the same Zero Static valve.

Typical Applications:

- A single use point with multiple outlets for purging and steam sterilization of the downstream line and sampling of the upstream line

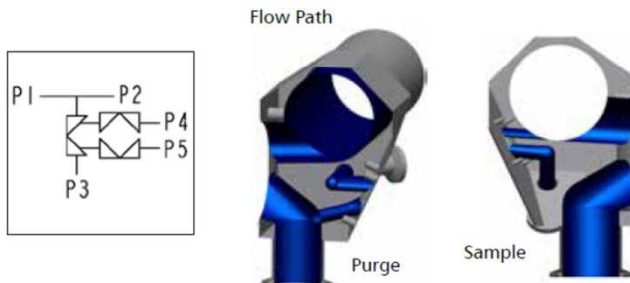
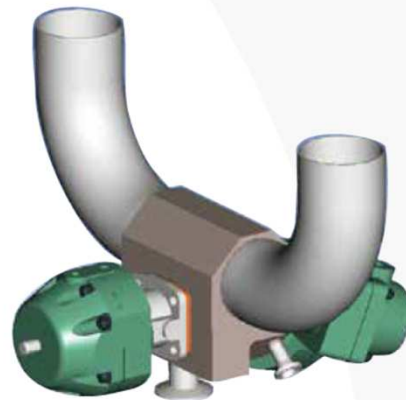

Integrated
Block Valves

Zero Static Block Body with Vertical Run (ZSBV)

Zero Static use points are some of the most critical valves utilized in the Biopharmaceutical industry. Use point valves allow process fluids to be transferred, sampled, drained or diverted with minimal impact on critical systems such as WFI and purified water.

Standard Zero Static valves are limited to horizontal main runs by vertical outlet orientations. The ZSBV greatly expands the use of the Zero Static valve by allowing optimal drainability and hold up volumes with the main run in the vertical orientation and the outlet in the horizontal orientation.

Typical Applications:

- Vertical run use point, sampling and diverting.

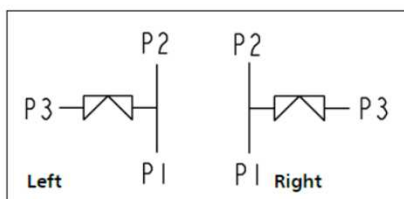
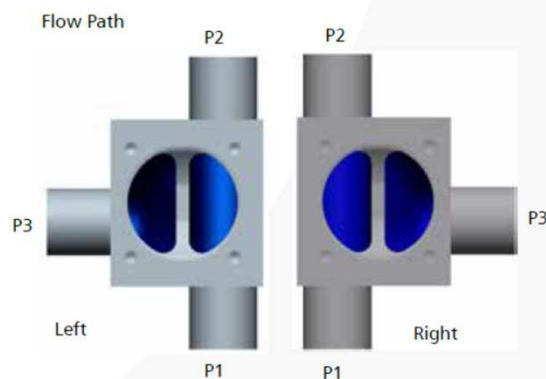
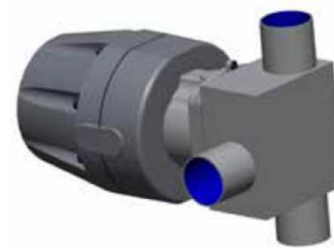

VALVULAS Y PROCESOS 2007, S.L.

Orfeó Català, nr. 9
Pol. Ind. Sud
08440 - CARDEDEU
SPAIN

TEL: 00 34 93 755 20 56
FAX: 00 34 93 755 17 75
e-mail: jpicallo@vypls.es
VAT: ESB64719958

Zero Static Use Points

Zero Static Inverted with Drain (ZID)

Zerostatic Inverted Drain valves integrate the benefits of a zero static for low point feed or return lines while allowing for cleaning, sterilization and draining of the connected process piping.

Typical Applications:

- For line feed applications that require the ability to drain the up stream line



Flow Path

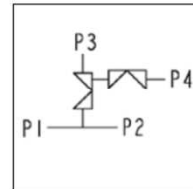
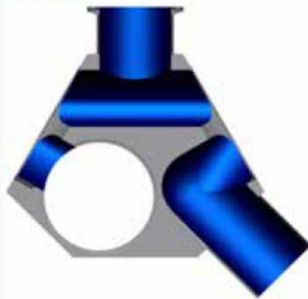

Integrated Block Valves

Zero Static Block Body with Back Outlet Option (ZSBT-BO)

The ZSBT-BO valve provides all the advantages of the standard zero static valve for transferring, sampling, draining and diverting critical fluids, while minimizing the vertical space required. Porting the outlet from the back of the valve substantially reduces the space necessary when piping would require a 90° elbow to change the direction.

Typical Applications:

- Low clearance areas below WFI and process vessels.
- Skidded process systems such as CIP.

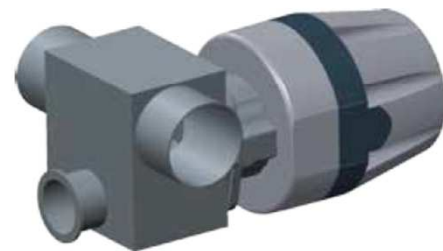

Flow Path

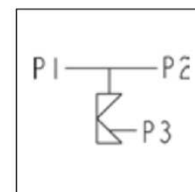
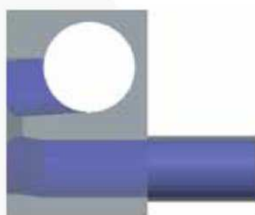

VALVULAS Y PROCESOS 2007, S.L.

Orfeo Català, nr. 9
Pol. Ind. Sud
08440 - CARDEDEU
SPAIN

TEL: 00 34 93 755 20 56
FAX: 00 34 93 755 17 75
e-mail: jpicallo@vypl.es
VAT: ESB64719958

Zero Static Use Points

Zero Static Dual Inline (ZDI)

Zero Static use points are some of the most critical valves utilized in the Biopharmaceutical industry. Zero Statics are used extensively on Water for Injection (WFI) and purified water loops. These water loops supply nearly every manufacturing process. Water loop maintenance is typically scheduled for annual shutdowns so as not to affect production. Critical applications or use point locations that require maintenance on a more frequent basis or that would affect a large portion of the plant water loop may require additional valves to isolate the main water loop for maintenance. The Zero Static Dual Inline valve was designed specifically to allow for maintenance of two use points with minimum loop downtime.

Typical Applications:

- Use points where the loop service intervals need to be maximized



Flow Path

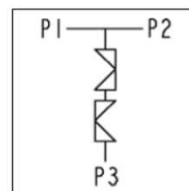

Integrated
Block Valves

VALVULAS Y PROCESOS 2007, S.L.

Orfeo Català, nr. 9

Pol. Ind. Sud

08440 - CARDEDEU

SPAIN

TEL:

00 34 93 755 20 56

FAX:

00 34 93 755 17 75

e-mail:

jpicallo@vypl.es

VAT:

ESB64719958